

PERF / SCORE ACCESORIES



Operating Instructions
SP200



1.0 Introduction

Thank you for your purchase of the **Martin Yale** 2-Pass Scoring/Perforating machines. With proper maintenance your unit will provide you with years of service. Upon receiving the machine verify that there are no signs of shipping damage on the exterior. If you feel the product may have been damaged in transit, contact the appropriate freight carrier immediately, then contact technical support at Martin Yale Industries, Inc. at 260-563-0641 option 2.

Upon opening the machine, verify that you have the following components.

2.0 Inventory of Contents

- SP200 Unit
- Catch Tray W-ODT0021
- Paper Support W-ODT1124
- 3/32" T- Handle Allen M-S012012
- Operating Instructions
- 8.5" Top Plate W-ODT0100
- 11.0" Top Plate W-ODT0200

Model:
Serial No:
Manuf. Date:

3.0 Specifications

- > Accessory shafts can be easily disassembled for addition of optional components.
- > Units will handle 24# bond to 100# cover stock.
- > Min. Sheet Size 4 1/8" X 3 1/2"
- > Max. Sheet Size 8 1/2" X 11"
- > Speed: SP100: 1400 8 1/2" X 11" sheets per hour using 2 passes.

SHIPPING WEIGHT

-MODEL SP200 35 lb

 **MARTIN YALE**
Industries
251 Wedcor Avenue • Wabash, Indiana 46992
Phone (260) 563-0641 • Fax (260) 563-4575
Email: info@martinyale.com • Website: www.martinyale.com

4.0 Set up from carton to table

Caution: The unit contains rotating blades and other dangerous items. Do not remove any safety covers from the machine. Be aware that loose jewelry, long hair and loose fitting clothes should be kept away from the unit.

1. Set the machine on a tabletop. Verify the power switch is set to "0" (off position).
2. Look in each feed shelf of your unit, and verify that the tips of the sheet Separator (see Fig. 1) are not in contact with the feed wheels. These are preset at the factory and should not need to be adjusted.

Note: If the machine is operated with the Sheet Separator in contact with the feed wheels the wheels could be damaged.

Make sure that the Sheet Separator tips are not touching the Feed Wheel in each shelf when the machine is turned on.

Sheet Separator

Sheet Separator is factory set to .012 gap and should not need to be adjusted for typical 65# stock.

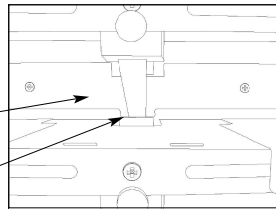

Figure 1

- 2a. Remove taped accessories from the exit tray shelves. These are used as Top Plates on top of the stack to insure accurate tracking of curled stocks, or for stocks that require additional control for accurate feeding. See Fig. 2.

Make sure that the Top Plates are removed from the feed bins before the machine is run for the first time.



Figure 2

3. Turn rocker switch to "1". The unit should begin running. If there is no power, try the following:

- 3a. Check the electrical outlet to verify function. A good way to do this is to plug in another device that you know works.
- 3b. If still no power, check that circuit breaker has not tripped. Find source of machine bind and correct. Allow machine to cool and push breaker in to reset.
- 3c. Call the technical support division at Martin Yale Industries, Inc. at 260-563-0641 option 2.

4.1 Tray/ Paper Support Installation

Install the Paper Support and Catch Tray onto the machine. A Paper Support is utilized on the in-feed of any bin where the sheets overhang the edge of the Feed Shelf. The Paper Support is installed by inserting the tabs into the slots on the front of the feed shelves as shown in Fig. 3. The Catch Tray is inserted into the slots on the back of the machine of the section being used and rests against the Rear Cover (see Fig. 4).

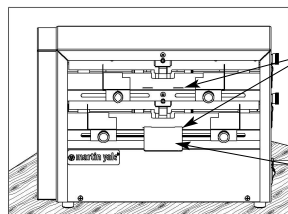

Figure 3

Insert tabs into slots of section being used

Paper Support is used when sheets overhang the edge of the Feed Shelf

Catch Tray hangs on back of section being used.

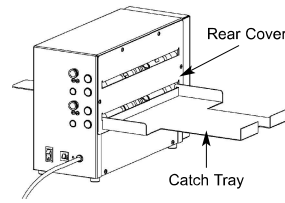
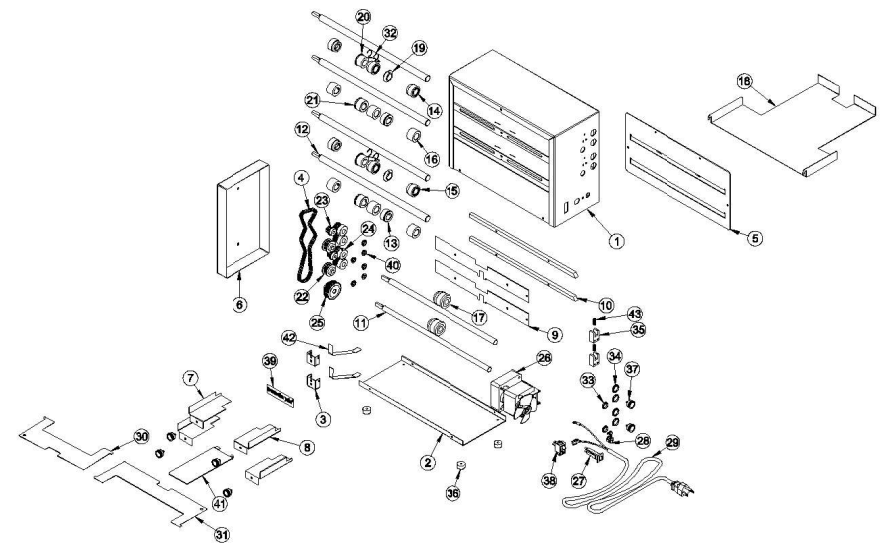

Figure 4

2

SP200 Parts List

Item	Part No.	Description	Item	Part No.	Description	Qty	
1.	W-OCD0001	CD200 Housing	1	23	M-S022130	10T Nylon Pulley	2
2.	W-ODT0022	Bottom Cover	1	24.	M-S022015	12 T Pulley .375 Bore	4
3.	W-IDT1119	Pem Feed Bracket	2	25.	M-S63751634	Timing Pull.Set Scrw	1
4.	M-S025053	95T Dbl Sided Belt	1	26.	M-S021073	BCS AC Gearmotor 110V	1
5.	W-OCD0002	CD200 Rear Cover	1	27.	M-S045320	2A BCS Cir. Breaker	1
6.	W-ODT0011	200 Drive Cover	1	28.	M-S035015	Heyco SR 5P-4	1
7.	W-ODT0013	L.H. Guide	2	29.	M-S037020	18/3 SV Cord 8ft Lg	1
8.	W-ODT0014	R.H. Guide	2	30.	W-ODT0101	210mm Top Plate	1
9.	W-ODT0015	Sheet Separator	2	31.	W-ODT0202	11 In Top Plate Female	1
10.	W-ODT0016	Adjustment Bar	2	32.	M-ODT1126	Perf Stripper Wire	2
11.	W-ODT0017	B/O Slitter Shaft	2	33.	M-S014030	1/2 Iglide Clip Brg	2
12.	W-ODT0018	Perf/Score Shaft	4	34.	M-S014031	5/8 Iglide Clip Brg	4
13.	M-O003082	Scoring Roll Back Up	2	35.	W-ODT0019	Mach. Adjust Block	2
14.	W-O003079	Acc. Bushing	6	36.	M-S030045	755 RW Bumpers	4
15.	M-O003080	Acc. Rubber	6	37.	M-S032007	8-32" X 1/4" Knob	6
16.	W-O003076	Acc. Guide Roller	6	38.	M-S033053	SPST Rocker Switch O-I	1
17.	W-OGC0026	Feed Wheel Assembly	2	39.	Martin Yale Label	1	
18.	M-S022130	10up Catch Tray	1	40.	M-S014029	Iglide Clip Bearing	6
19.	M-O003083	Scoring Roller	2	41.	W-ODT1124	Paper Support	1
20.	W-A03085D	14 Tooth Perf Assy	2	42.	W-ODT1123	Form Pressure Finger	2
21.	W-ODT1109	Groove Guide Roll	2	43.	M-S031081	Sp. Lee LC-032B-04-M	2
22.	M-S022132	15t Alum Hub Pulley	2				



7

7.0 Troubleshooting

Multiple Sheet Feeding:

1. Set feed system per Section 5.1.
2. If stock is glossy the feed wheels of the machine may have grip issues. This is a common issue with friction-fed units. If one side is not glossy, run through with glossy side facing up.

Scoring / Perforating Issues:

Scoring roller cutting stock:

The solution to this is to humidify your stock. Typically only very dry material will do this.

Poor perforation or score:

1. Check the nearness of the guide roller to the score or perforation wheel. If possible, position for better function to the extreme edges of the stock.
2. Verify that the set screws in the accessories have been tightened (scoring roller does not use a setscrew).

7.1 Maintenance

Proper maintenance of your unit will prevent most situations that cause damage. Follow the steps below to maintain the unit.

1. Once every 60 days, clean all paper dust from the unit.
2. Once every 90 days, check the Phillips head screws in each Sheet Separator and make sure they are tight.
3. Periodically, check the power cord of the machine for frays and pinches. Replace cord should any damage be found.
4. As needed, clean feed wheels on the unit with mild cleaner and a Scotch-Brite pad.

SP200 Wiring Diagram

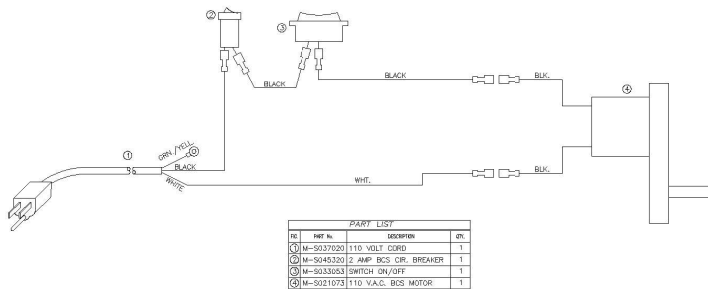

6

5.0 Setting Paper Guides

Perform the following steps in order to achieve accurate registration.

1. Loosen the thumb knobs on the Paper Guides for the appropriate shelf (see Fig. 5).
2. Position paper guides so that side-to-side movement will be no more than 1/32". NOTE: The guides should not pinch the stock. Inaccurate feeding could result if too tight (Fig. 6).
3. Feed single sheets to test for accuracy. Readjust paper guides as necessary.

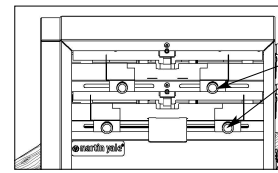

Figure 5

Paper Guide
Thumb Knobs
(2 Pairs)

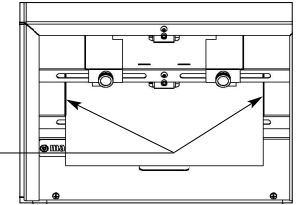

Figure 6

Paper Guide to
stock adjustment.
Watch for pinching of
stock at these points

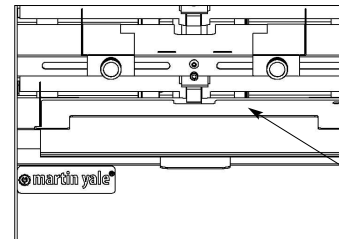

Figure 7

Top Plate

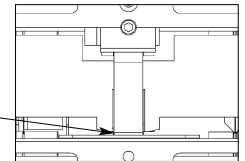

Figure 8

Pressure Finger
should rest in the
groove of the feed
wheel.

Feeding Thermographic or severely curled stock:

In some applications a hesitant feed can occur if the raise of the lettering prevents the Sheet Separator from functioning normally. This can also occur with heavier stocks should they develop a curl when printed.

Should this become an issue, the following steps can be performed:

1. Run stock through image side down.
2. Apply some weight to the stock for a period of time before it is to be run.
3. Use the 11.0" or 210mm top plates on top of the stock. (Fig. 7)

Should stock still have feed issues call technical support at Martin Yale Industries, Inc. at 260-563-0641.

Obtaining Service

Should your machine need to be professionally serviced, Martin Yale Industries, Inc. can refer you to the nearest Factory Authorized Technician. Contact us at the phone number given above.

3

6.0 Accessory Function

Factory standard accessories include scoring wheels and perforator wheels. Each component uses its own cutting hub as an assembly. The components cannot be separated.

To engage the scoring roller, follow the instructions below:

1. Loosen the 3/32" Allen set screw in the lower back up hub.
2. Slide the scoring roller and hub to the appropriate location.
3. Retighten the setscrew in the back up hub.

Remove back cover to access scoring & perf wheels

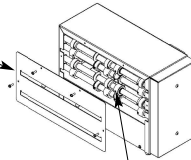

Loosen set screws to make adjustments

Figure 9

To engage the perforator wheel, follow the instructions below:

1. Loosen the 3/32" Allen set screw in the perforating wheel and in the backup hub.
2. Slide components to the appropriate location. Retighten both setscrews.

NOTE: THE BACKUP HUBS ARE NOT INTENDED TO BE SEPARATED FROM THEIR UPPER COUNTER PART. DO NOT ATTEMPT TO SEPARATE THESE ITEMS.

NOTE: Insure the Perf Stripper Wire is placed around the 14 Tooth Perf Assy to keep the paper from wrapping around the perforating wheel.

NOTE: Positioning of the feed rollers to the scoring/perforating blade should be located at the left edge and right edge of stock being used.

NOTE: OVERTIGHTENING OF SET SCREWS CAN CAUSE STRIPPING. WHEN TIGHTENING ACCESSORIES, SCREWS SHOULD BE APPLIED 1/8-1/16 OF A TURN PAST SNUG.

6.1 To remove or replace the accessories:

1. **Unplug the machine!**
2. Remove the Drive cover (on opposite side of machine from the power switch) Fig. 10
3. Loosen but do not remove the four hex head screws from around the lower pulley. (this is the motor pulley.)
4. Lift up on the lower pulley to loosen the belt. Fig. 11
5. Remove the belt.
6. Remove the four top pulleys connected to the accessory shafts.
7. The accessory shafts may now be pushed into the machine and the accessories may be moved around, removed or replaced easily. Fig. 12
8. The Groove Guide Roll and the 14 Tooth Perf Assy have a set screw holding them in place. The Scoring roller does not have a set screw and should be allowed to turn freely.

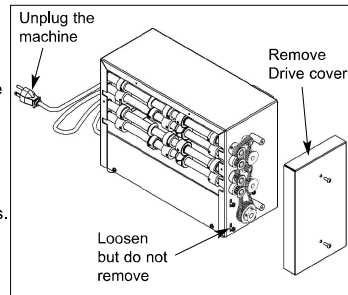
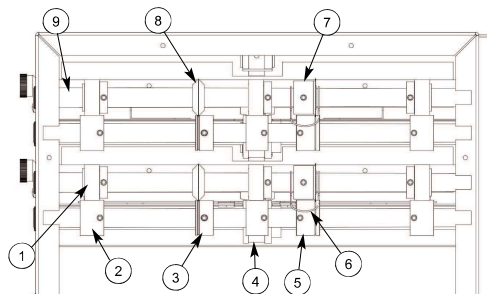

Figure 10



4

1. Accessory Roller
2. Accessory Guide Roller
3. Scoring Roll Backup
4. Feed Wheel Assembly
5. Groove Guide Roll
6. Perf Stripper Wire
7. 14 Tooth Perf Assy
8. Scoring Roller
9. Accessory Shaft

9. The Perf Stripper Wire should be placed around the Slitter Hub Assembly to keep the paper from wrapping around the perforator.

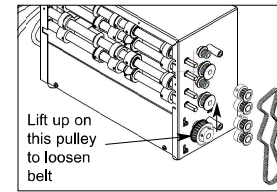

Figure 11

10. Keep the Accessory guide rollers to the outside of the paper as far as you can and keep them symmetrical. (They should be the same distance from the edge of the paper on each side) The center accessory guide roller should be near the center.

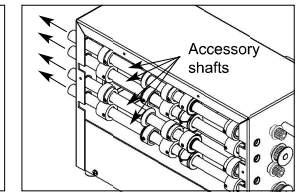

Figure 12

11. Once everything is in position, slide the shafts back into place.

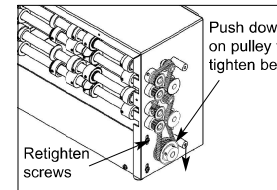

Figure 13

12. Reinstall the pulleys and the belt.

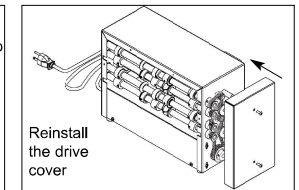

Figure 14

13. Push down on the lower pulley to tighten the belt then retighten the hex head screws around the lower pulley. Fig. 13

14. Reinstall the Drive cover. Fig. 14

6.2 To adjust the sheet separator:

The Sheet Separator is the piece of metal with two tabs on a vertical piece of metal above the Feed Wheel. Fig. 15

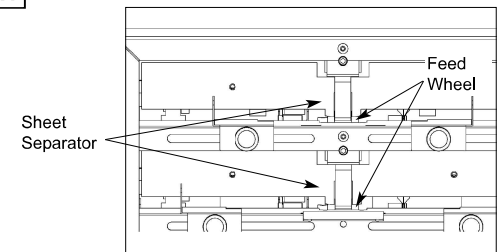

Figure 15

Each section has its own Sheet Separator adjustment.

Adjust the gap between the Feed Wheel and the Sheet Separator using the knob on the side of the machine (Fig. 16) until the gap is equal to the thickness of the paper. You can do this by raising the Sheet Separator slightly, insert a piece of your paper, then adjust the Sheet Separator down while moving your paper. When you feel the Sheet Separator rubbing the paper it is adjusted.

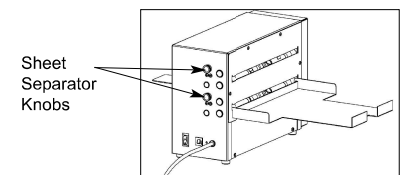

Figure 16

Repeat for both sections.

5